

Intelligent Air Motor Controller

iAMC1200



Key Features



Designed to be lightweight with outstanding power density



Built for industrial-strength, longevity, and safety



100% tested with individual performance reports



Self-cooling by design

Fly Higher. Fly Longer. Fly Smarter.

Unmanned aerial vehicle (UAV) electronics continue to evolve as mission profiles become more demanding. System power designers are being challenged to provide more innovative power supply systems to improve efficiency, ensure reliability, reduce weight, minimize heat dissipation, and lower overall cost. New levels of energy and system-level efficiencies are also required to meet tomorrow's aviation needs.

ePropelled intelligent air motor controllers (iAMC), or electronic speed controllers (ESC), are built to work alongside our lightweight propulsion motors. Together, they create a high-performance, high-efficiency propulsion system for your aircraft. Our iAMCs transform DC input voltage into a 3-phase AC output voltage and act as the brain of the electric motor. iAMCs can also sense minute changes in the motor's direction, acceleration, and other parameters and will automatically adapt to it for optimized stability and precision control.

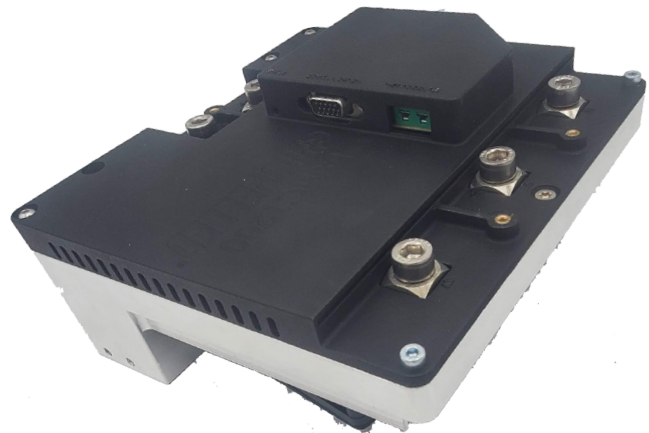
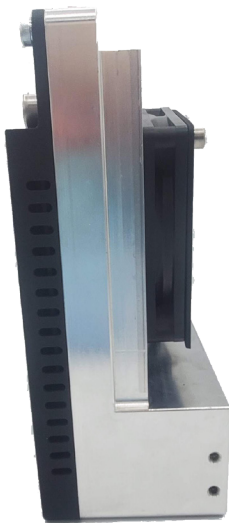

iAMC1200 SPECIFICATIONS	
Parameter	Values/Details
Input voltage range	48 V - 100 V
Input battery configuration	(12S Lixx ⁰) - (24S Lixx ⁰)
Antispark protection	Yes
Motor compatibility	Brushless, sensorless
Output phase current (30 s)	350 A _{pk} [248 A _{rms}]
Output phase current (180 s)	300 A _{pk} [212 A _{rms}]
Output phase current (continuous)	175 A _{pk} [124 A _{rms}]
Peak input power (30 s)	15,000 W [min 84 V _{dc}]
Peak input power (180 s)	12,000 W [min 84 V _{dc}]
Continuous input power	6,000 W
Efficiency	Up to 98%
Inverter switching frequency	50 kHz
Advance angle control	0°, 10°, 20°, 30°, 40°
Maximum electrical frequency	2.67 kHz
Ambient temperature range	0°C to 40°C [32°F to 104°F]
Maximum internal inverter temperature	100°C [212°F]
Motor temperature measurement	Yes
Motor temperature protection	Yes
Power connection	2 X M8 screw terminal
Motor lead	3 X M8 screw terminal
Communication	CAN 2.0 A
Speed commands	PWM or CAN command via eP Connect
Real-time data monitoring (RTDM)	Yes (10 data points with speed, current, and temperatures)
IP rating	IP20
Cooling airflow for operation without fan	5 m/s
CAN connector	DB15-HD
Speed command connector	DB15-HD
Weight	1,950 g
Dimensions (L x W x H)	180 mm x 190 mm x 91.5 mm
Configurable parameters	24 parameters covering system, motor, inverter, PWM input & alert thresholds
Alerts via CAN bus	Alerts covering 18 conditions
Multiple iAMCs can be used on the same CAN bus	Up to 15 devices

Notes

- ▶ Lixx⁰ = LiFePo4 or LiPo
- ▶ Errors and omissions excepted

Derating with Increased Altitude

The derating factor for altitude is based on the loss of dielectric strength of the air as the density decrease with the altitude. The diagram below shows how the cooling efficiency changes with high altitude and ambient temperatures.

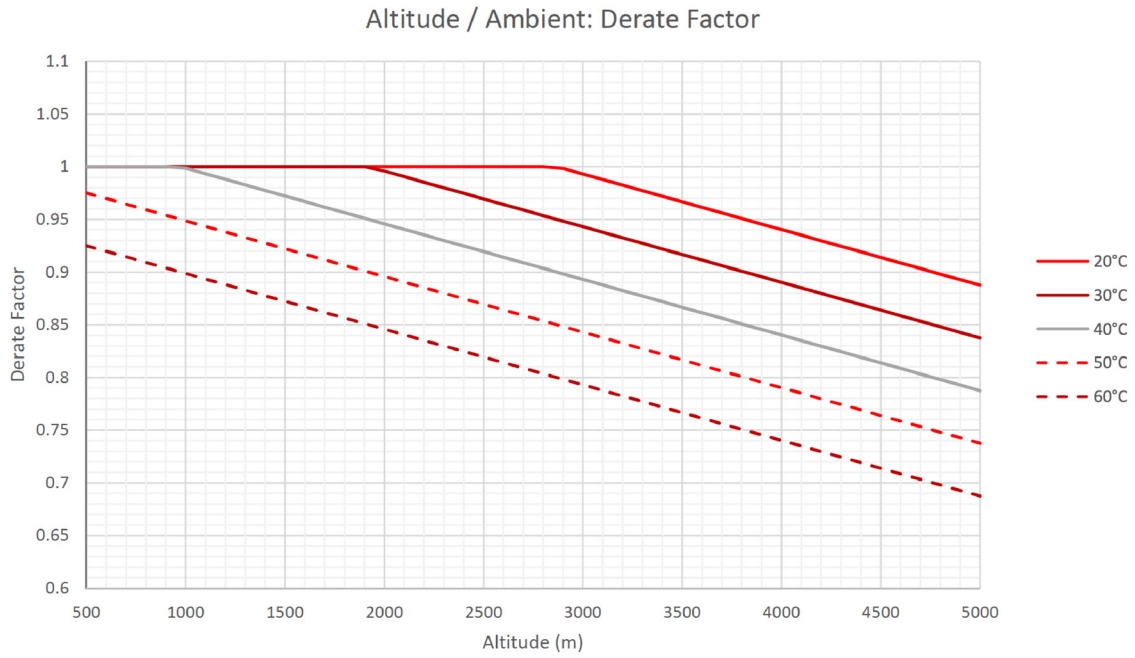

INTELLIGENT AIR MOTOR CONTROLLER iAMC1200 DIMENSIONS

Dimensions given in mm. Mounting holes are marked in red.

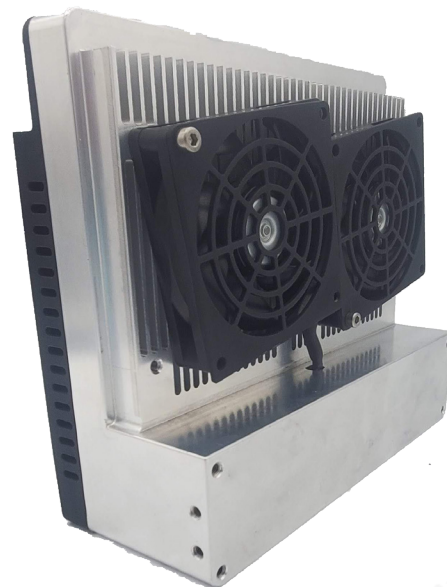
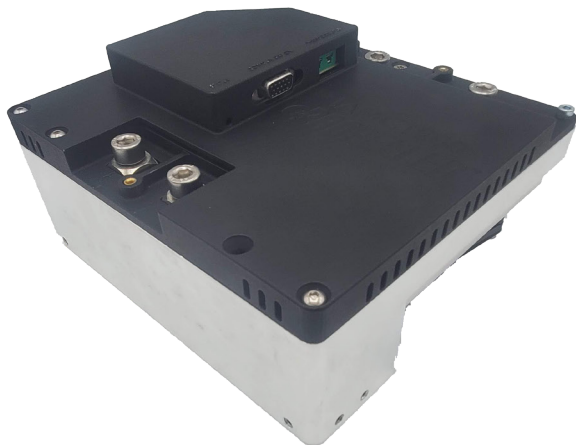
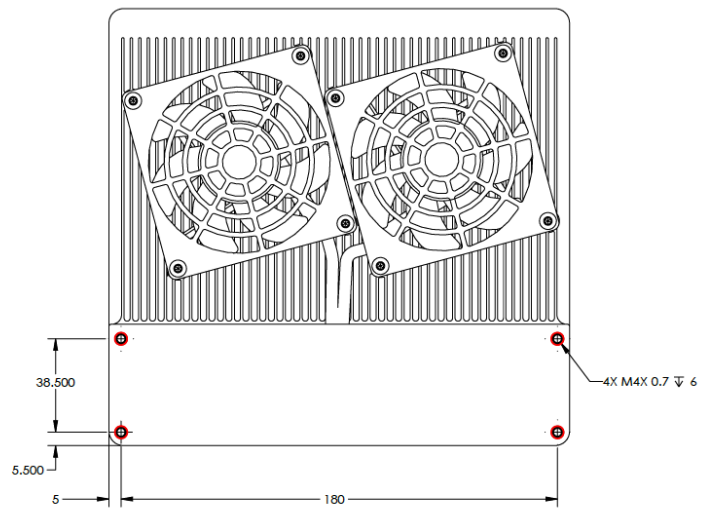
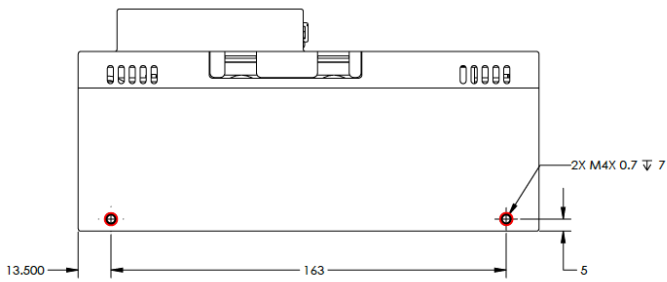
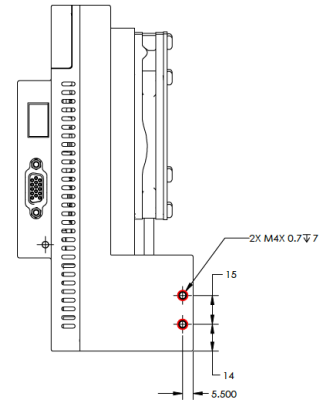
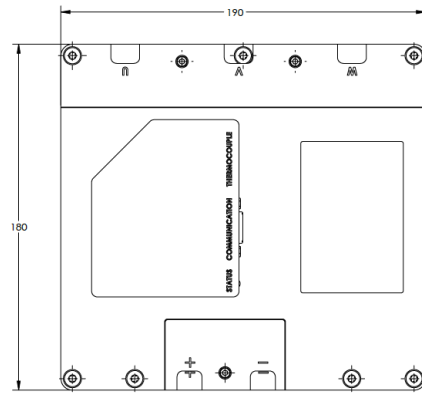
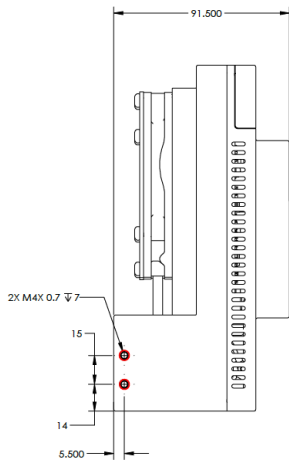

iAMC1200 PINOUT		
Connector Type	Pin Name	Pin Description
Power (M8 screw terminals)	U	U phase input connection for PM
	V	V phase input connection for PM
	W	W phase input connection for PM
	+	Positive input connection DC supply/battery
	-	Negative input connection DC supply/battery

iAMC1200 PINOUT	
DB15 Pin	Pin Name
1	Not used. Do not connect
2	Not used. Do not connect
3	Not used. Do not connect
4	GND
5	CANH
6	Not used. Do not connect
7	Not used. Do not connect
8	Not used. Do not connect
9	Not used. Do not connect
10	CANL
11	TMS
12	TCK
13	Not used. Do not connect
14	Not used. Do not connect
15	PPM/PWM Input
Chas	GND

iAMC1200 K-TYPE THERMOCOUPLE INPUT	
TC	Pin Name
+	Positive TC input
-	Negative TC input

Assembled in USA

Errors and omissions excepted. All specifications subject to change without notice. For more information, including ordering product, please contact us at info@ePropelled.com.

Copyright © ePropelled Inc. 2022. All rights reserved.

This document is copyrighted and all rights are reserved.

Disclosure of this document to third parties in whole or in part or use of the information herein for purposes other than those described herein is not permitted, except with the prior written consent of the copyright holder.

The copyright holder makes no representations or warranties with respect to the contents hereof and specifically disclaims any implied warranties of fitness for any particular purpose. The information in this document is subject to change without notice. The copyright holder assumes no responsibility for any errors that may appear in this document.

ePropelled, SwimDrive, Hybrid Ready, The Future of Electric Propulsion, eDTS, and Dynamic Torque Switching are trademarks of ePropelled.

Warnings and Labels



ePropelled © 2022. ePropelled designs intelligent motors, motor controllers, and power management systems that help reduce energy consumption and dramatically improve system efficiency at a lower cost. Our patented technology and innovative smart systems are equally at home in the air, on the road, and in water, leading the way towards a greener future.

ePropelled has offices in the United States, Europe, and India and works with manufacturers of various types and sizes around the world. For more information, visit ePropelled.com